



# **PermaLife™**

## AIR PURIFIER









**Model 30546 & 30547**  
*(remote included)*

### Replacement Filter Information

<u>MODEL</u>	<u>PRE-FILTER</u>
30546	30901
30547	30901

[www.hunterfan.com](http://www.hunterfan.com)

# Table of Contents

<b>Safety Instructions</b> .....	3
<b>Introduction</b> .....	3
 <b>Description of Air Filtration System</b>	
How the PermaLife™ Air Purifier System Works .....	4
Air Purifier Components .....	4
Display and Control Keys .....	5
 <b>Operation</b>	
Initial Operation .....	6
Remote Operation .....	8
Display Modes .....	9
Manual and Auto Operating Modes .....	10
Using the Ionizer .....	11
Override of Auto Mode .....	12
Filter Run-Time Counters .....	13
 <b>Programming</b>	
Setting Day and Time .....	14
Pre-set Programming .....	15
User Programming .....	16
Reviewing Programs .....	18
Locking/Unlocking the Keypad .....	18
Resetting the Air Purifier .....	19
 <b>Air Purifier Maintenance</b>	
Cleaning Your Air Purifier .....	20
Changing the Pre-Filter .....	20
Cleaning the Filter .....	21
Obtaining Replacement Filters .....	22
 <b>Troubleshooting</b>	
Problem and Solutions .....	23
Technical Support .....	23
 <b>Warranty Information</b> .....	24

# SAFETY INSTRUCTIONS

## IMPORTANT!

### READ ALL INSTRUCTIONS BEFORE USING THIS AIR PURIFIER.

1. This air purifier is designed for use on a flat level floor and may not work properly on an uneven floor. **ALWAYS** place the air purifier on a firm level floor. **ALWAYS** place the air purifier at least six (6) inches away from walls and heat sources such as stoves, radiators, or heaters.
2. Place the air purifier in an area that is out of the reach of children.
3. Before using the air purifier, extend the cord and inspect for any signs of damage. **DO NOT** use the product if the cord has been damaged.
4. This product has a polarized plug (one blade is wider than the other) as a safety feature. This plug will fit into a polarized outlet only one way. If the plug does not fit fully into the outlet, reverse the plug. If the plug still does not fit, contact a qualified electrician. **DO NOT** attempt to defeat or override this safety feature.
5. **ALWAYS UNPLUG** the air purifier while it is being cleaned.
6. **DO NOT** move or tilt the air purifier while it is in operation. Turn off and unplug before moving.
7. **DO NOT** immerse the air purifier in water at any time because permanent damage will occur. To properly clean your air purifier, follow cleaneo

maquag pg. 20).1



# Description of Air Filtration System

## How the PermaLife™ Air Purifier System Works

As the air is pulled into the purifier, the activated carbon pre-filter absorbs odors and catches large particles. Then, the air travels through the PermaLife™ Cleanable Filtration System where the smaller particles are collected. Then, the ionizer releases negative ions into the air that attract positively charged dust, smoke, and pollen particles. Finally, the clean purified air is released back into the room.

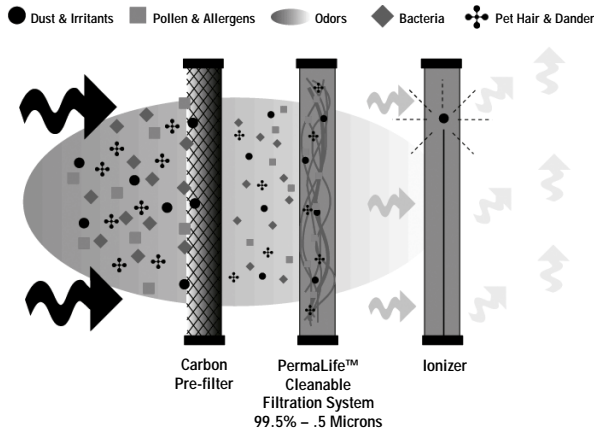

Fig. 1 - Illustration of the Air Filtration System

## Air Purifier Components

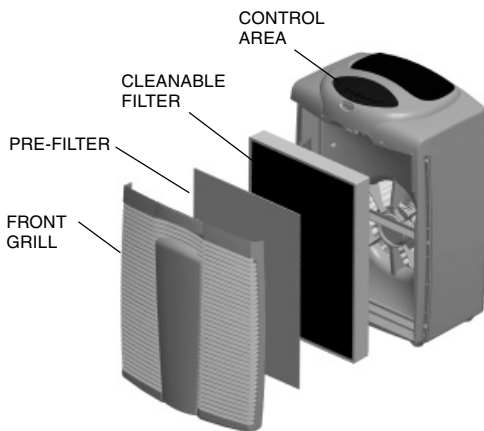

Fig. 2 - Air Purifier Components

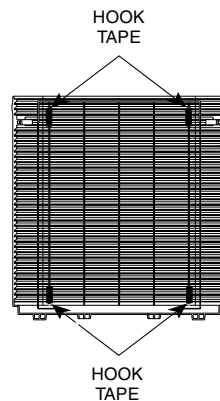

Fig. 3 - Inside Surface of Front Grill

# Description of Air Filtration System



## Display and Control Keys

The display and control keys allow for easy operation of the air purifier.

**IONIZER:** Turns the ionizer on and off.

**ON/OFF:** Turns the unit on and off.

**AUTO:** Toggles between manual and auto modes. (*Manual mode and Auto mode on page 10.*)

**UP/DOWN KEYS:** Adjusts the blower speed and changes values in clock setting and programming modes.

**FILTER RESET:** Resets the pre-filter and filter counters. (*Filter run-time counters on page 13.*)

**DISPLAY:** Selects the clock, pre-filter, or filter display. (*Display modes on page 9.*)

**DAY/TIME:** Used to set the day and time. (*Setting day and time on page 14.*)

**PROGRAM:** Allows you to enter program mode and define user programs. (*User programming on page 16.*)

**RESET:** Returns unit to factory settings. (*Resetting the air purifier on page 19.*)

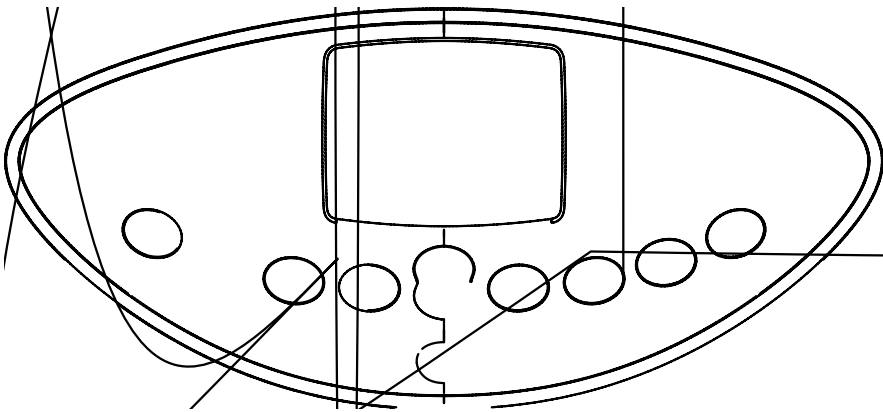

**Fig. 4 - Air Purifier Control Area and Alpha-numeric Display**



## Operation

### Initial Operation

This section provides basic instructions on the use of your air purifier. After following these initial directions, please continue reading this booklet to learn how to operate the more advanced features of your air purifier.

#### *Basic Operation of the Air Purifier:*

1. Take the air purifier out of the box and remove the clear plastic protective bag. Place the unit on a firm level floor.
2. Before turning on the air purifier, you need to confirm that the filters are firmly in place and have not become loose during shipping. To check the filters, first open the front grill by placing your fingers under the handle and pulling the front grill towards you. The front grill will rest open at about 45°. You can remove the front grill by placing your fingers under the handle and pulling the front grill towards you and then up. Refer to Fig. 5.

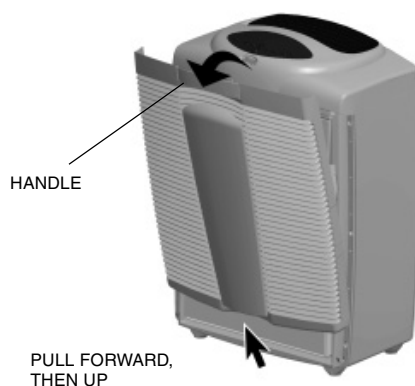

Fig. 5

3. Next, check the cleanable filter by pressing firmly on all four corners of the filter to ensure that it is fully inserted into the filter opening.
4. The carbon pre-filter is mounted inside the front grill with hook tape. Confirm that it properly covers the grill vents. You may notice a few black particles coming off the pre-filter. Those particles are part of the odor-removing activated carbon and will be collected on the filter during use.
5. Place the front grill back onto the unit. First, line up the tabs on the bottom of the grill with the openings on the purifier base and then push the top of the grill forward until it is closed. **NOTE:** This unit will not operate unless the grill is in the correct position. The display will read “door” if the grill is not attached properly.



6. Plug the unit into a 120V electrical outlet and press the ON/OFF key. The air purifier will start with a low blower speed.
7. Use the UP/DOWN keys to adjust the blower speed to the desired level.

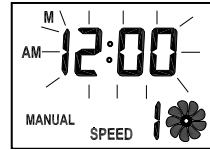

Fig. 6

If this is the first time you have used the air purifier or if the air purifier has been without power for over 12 hours, you will need to set the day and time. The day and time will flash to indicate that it should be set.

### *Adjusting Day and Time: (For example, Wednesday at 3:45 pm)*

1. To set the day or time, press the DAY/TIME key. All display features except the day and time will go blank and the hour will flash.
2. Use the UP/DOWN keys to adjust the hour. Tapping the key will advance the hour by increments of one. Holding down the key will change the hour rapidly. Note the AM/PM indicator as you cycle through a 24 hour period.
3. Press the DAY/TIME key again. Now, the minutes will be flashing. Use the UP/DOWN keys to adjust the minute. Tapping the key will change the minute by increments of one and holding the key will change the minute rapidly.
4. Press the DAY/TIME key to accept the minute setting and go to the day of the week. Use the UP/DOWN keys to set the current day.
5. Press the DAY/TIME key a final time to accept the day setting and return to Normal mode.



Fig. 7

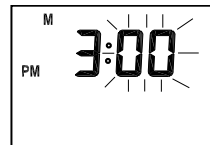

Fig. 8

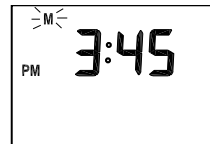

Fig. 9



Fig. 10



## Operation

---

### Remote Operation

For your convenience, a remote control is provided with this air purifier. The remote may be used to turn the air purifier on or off and adjust the fan speed.

#### *Operating the Air Purifier with the remote:*



1. Install two AAA batteries (UM-4 or IEC R03 or equivalent). Refer to the graphics in the battery compartment for proper orientation of the batteries.

**WARNING:** Do not mix old and new batteries. Do not mix alkaline, standard (carbon-zinc), or rechargeable (nickel cadmium) batteries.



2. To use the remote, point it at the air purifier, then press and release the appropriate key. The key functions are as follows: 0 - OFF, 1 - LOW, 2 - MEDIUM, and 3 - HIGH.

When using the remote, the air purifier remains in the mode that it is currently set for.

When the keypad is locked, the remote may still be used to adjust the speed or turn off the air purifier.

If the remote is not working properly, first be sure that the remote is facing the air purifier when pressing the key. If it still does not work, check the batteries.





## Display Modes

Your air purifier has 3 display modes – Clock Display, Pre-Filter Display, and Filter Display. When the unit is running, the display also provides additional information about the settings of the air purifier. The features for each mode and how to change modes is described below.

**Clock Display:** The default mode of the unit is the Clock Display. In this mode, the day indicator, time, and AM/PM indicator will be lit. If military time has been chosen (See Setting Day and Time, pg. 14), the AM/PM indicator will not be visible.

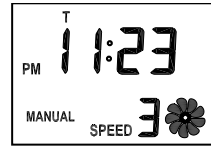

**Fig. 11**  
Clock Display

**Pre-Filter Display:** This display shows the number of hours that the pre-filter has been in use. In addition to the run hours, you will see the Pre-Filter indicator. If the run hours have reached 1400 hours (approximately 3 months of use), the Pre-Filter indicator will flash to show that the pre-filter should be changed. Refer to Filter Run-Time Counters for additional information (pg. 13).

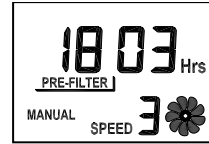

**Fig. 12**  
Pre-Filter Display

**Filter Display:** The Filter Display mode tells you how many hours the filter has been in use. In addition to the run hours, you will see the Filter indicator. If the run-hours have reached 2800 hours (approximately 1 year of use), the Filter indicator will flash to remind you to check the filter. Refer to Filter Run-Time Counters for more details (pg. 13).



**Fig. 13**  
Filter Display

### Changing Display Mode:

1. To toggle from Clock Display to Pre-Filter Display to Filter Display, press the DISPLAY key.
2. The DISPLAY key is active any time that the display is visible.

When the air purifier is turned on, the following features are also shown. If the unit is turned off by the On/Off key, these features are not displayed.

- Speed Indicator to show blower setting (0, 1, 2, or 3).
- Animated Blower Wheel will rotate when blower is on.
- Control Mode is indicated by AUTO or MANUAL.
- The Current Program number is visible when the unit is in Auto Mode.



# Operation

## Manual and Auto Operating Modes

Your Hunter Air Purifier has two distinct operating modes – Manual and Auto. The Manual Mode allows you to override the control programs that have been set and to hold the settings until you adjust them. In Manual Mode, the automatic programs are not active. You select whether the unit is on or off and choose the blower speed. In Auto Mode, your air purifier is capable of running 4 separate programs for the weekdays and an additional 4 programs for the weekend. You can choose to have the same programs for every day or you can have different programs for the weekdays and the weekend. The air purifier is pre-programmed for all 7 days of the week as shown below. Refer to User Programming on pg. 16 for instructions on changing the programs.

When using the remote, the air purifier remains in the mode that it is currently set for.

**Table 1: Pre-set Programming Provided for Each Air Purifier**

Program	Setpoint Time	Blower Speed
1	8:00 am	2 (Medium)
2	3:00 pm	3 (High)
3	5:00 pm	2 (Medium)
4	10:00 pm	1 (Low)

**To switch between Manual and Auto Modes:**

1. To change operating modes, press the AUTO key. The current operating mode will appear on the display (either AUTO or MANUAL).
2. When changed to Auto Mode, the unit will automatically adjust its controls to the appropriate program for the day and time. When Manual Mode is active, the unit will maintain current settings until you change them.

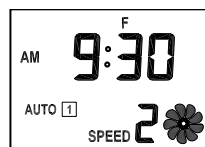

**Fig. 14  
Auto Mode**

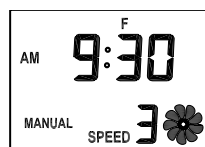

**Fig. 15  
Manual Mode**



## Using the Ionizer

Using the ionizer improves the quality of air in the room. Negative ions are released into the air and positively charged dust, smoke, and pollen particles are attracted to the negative ions. These particles settle out of the air and can be vacuumed up during normal cleaning. These particles are also more easily captured by the cleanable filter as they pass through the PermaLife™ Cleanable Filtration System. To ensure the best air circulation in the room, we recommend that you place your air purifier six (6) inches away from any walls.

### *To turn the ionizer on or off:*

1. To turn the ionizer on, press the IONIZER key. The word IONIZER will appear in the lower-left corner of the display.
2. To turn the ionizer off, press the IONIZER key. The word IONIZER will disappear from the display.



## Operation

### Override of Auto Mode

You can use two different methods to override Auto Mode. If you choose temporary override, the air purifier will run at the temporary setting until the next scheduled program change. Permanent override will remain in effect until you return the unit to auto mode.

When in Auto Mode, remote use acts as a temporary override.

#### *Temporary Override*

• *To temporarily override the settings:*

1. While the Auto Mode is active, use the UP/DOWN keys to adjust the blower speed. To temporarily turn the blower off, turn the blower speed to 0. This will allow the program to automatically continue at the next scheduled program change.
2. The air purifier will automatically adjust to the new setting. The current program number will flash to signify the temporary override.

• *To end the temporary override:*

1. The temporary override will automatically end at the next scheduled program change.
2. To immediately end the temporary override and return to the program, press the AUTO key twice. The air purifier will return to Auto Mode and the scheduled program.

#### *Permanent Override*

• *To begin permanent override:*

1. Press the AUTO key to enter manual mode. On the display, you will see the word MANUAL illuminated. This indicates that the programs are no longer active and the unit is in Manual Mode.
2. Use UP/DOWN keys to adjust the blower speed.

• *To end the permanent override:*

1. Press the AUTO key. The display will now show the word AUTO.
2. The unit will automatically adjust its controls to the appropriate program for the day and time.

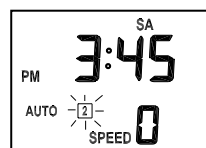

Fig. 16

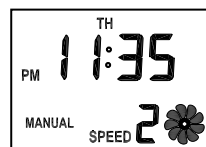

Fig. 17



## Filter Run-Time Counters

The pre-filter and filter are critical to the proper operation of the air purifier. To help you know when to change the filters, your Hunter Air Purifier has Filter Run-Time Counters that will monitor the number of hours your filters have been in use. Although the exact life of the filters depends on the environment, the table below gives typical usage times of the filters.

*Table 2: Typical Usage Times of the Filters*

Filter Type	Typical Usage
Activated Carbon Pre-Filter	1400 hours
Cleanable Filter	2800 hours

### *To check the run-hours for each filter:*

1. Press the DISPLAY key to toggle among the 3 display modes – Clock, Pre-Filter, and Filter. The Filter or Pre-Filter indicator will illuminate when the run hours for that filter are displayed.
2. The display shows the number of run hours since the counter was reset.

Although the maximum display value is 9,999 hours, the counters can go indefinitely. To indicate that the counter is over 9,999 hours, the display will flash. For example, a run time of 12,000 hours is represented by a flashing 2,000 hours.

The values of the Pre-Filter and Filter Counters are stored in the air purifier's memory. **The unit may be unplugged and moved without losing the pre-filter and filter counter values.**

To properly track filter usage, the Pre-Filter and Filter Counters should be reset each time the filters are changed. Refer to Changing the Pre-Filter (pg. 20) or Cleaning the Filter (pg. 21) for instructions on how to reset the counters.



## Programming

### Setting Day and Time

Setting the correct day and time allows the programs to work effectively and provides a clock for your reference. Although the instructions for setting the day and time are listed under Initial Operation, they are repeated below for your convenience.

#### *Adjusting Day and Time: (For example, Wednesday at 3:45 pm)*

1. To set the day or time, press the DAY/TIME key. All display features except the day and time will go blank and the hour will flash.



Fig. 18

2. Use the UP/DOWN keys to adjust the hour. Tapping the key will advance the hour by increments of one. Holding down the key will change the hour rapidly. Note the AM/PM indicator as you cycle through a 24 hour period.

3. Press the DAY/TIME key again. Now, the minutes will be flashing. Use the UP/DOWN keys to adjust the minute. Tapping the key will change the minute by increments of one and holding the key will change the minute rapidly.

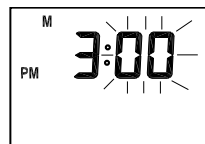

Fig. 19

4. Press the DAY/TIME key to accept the minute setting and go to the day of the week. Use the UP/DOWN keys to set the current day.

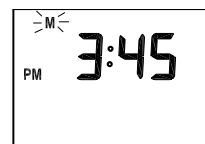

Fig. 20

5. Press the DAY/TIME key a final time to accept the day setting and return to Normal mode.



Fig. 21



## NOTES:

- The clock flashes when the time has not been set.
- At any time while you are setting the Day/Time, you can press the PROGRAM key to toggle between AM/PM format and military time format.
- To quickly exit the Day/Time setting mode, you can press the DISPLAY key or wait 15 seconds without pressing any keys.
- The time displayed will be frozen in Day/Time setting mode; however, the internal clock is still running. If no value is changed, then the frozen time will be replaced by the internal clock when you exit the Day/Time setting mode.
- **If the power is lost to the unit, the memory will maintain the clock for at least 12 hours.**

## Pre-set Programming

As discussed in the Manual and Auto Operating Modes section of the manual (pg. 10), your air purifier comes with pre-set programs. For your reference, these programs are listed again below. When you turn your air purifier to Auto Mode, these programs are active unless you override them with your personalized programs. Refer to the next section, User Programming, to learn how to input your own programs.

*Table 3: Pre-set programming provided for each air purifier.*

Program	Setpoint Time	Blower Speed
1	8:00 am	2 (Medium)
2	3:00 pm	3 (High)
3	5:00 pm	2 (Medium)
4	10:00 pm	1 (Low)



# Programming

## User Programming

User programming allows you to set when the air purifier is on and what blower speed to use. You may define up to 4 programs for the weekdays and up to 4 programs for the weekend. Before starting the programming process, first you should determine what times and blower speeds will best fit your needs. Use the charts below to organize and record the programs that you desire. Use a pencil so you can revise your records each time you change the programs.

Table 4

WEEKDAYS			WEEKENDS		
Program	Setpoint Time	Blower Speed	Program	Setpoint Time	Blower Speed
1			1		
2			2		
3			3		
4			4		

### NOTES:

- Setpoint time is the time at which the blower speed will change. The specified blower speed will be active until the next setpoint time is reached.
- The setpoint time can only be set in 10 minute increments.
- Blower speed ranges from 0 to 3. Zero indicates that the blower is turned off, a setting of 1 is low, 2 is medium, and 3 represents a blower speed of high.
- If you want the weekdays and the weekends to be identical, you should program both the weekday programs and the weekend programs with the same values.
- If you use less than 4 programs, set the unused programs identical to one of the other programs. Table 5 below gives an example where programs 3 and 4 are identical.

Table 5: Using 3 of the 4 Available Programs

Program	Setpoint Time	Blower Speed
1	8:00 am	3
2	5:00 pm	2
3	9:30 pm	1
4	9:30 pm	1



### To set or change the programs:

1. Press the PROGRAM key. Program 1 for weekdays will be shown with the hour position flashing to denote that you should set that value now.
2. Use the UP/DOWN keys to adjust the hour setting. Once set, press the PROGRAM key again.

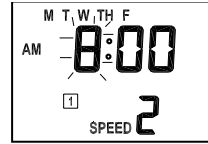

Fig. 22

3. Now, the minute position will be flashing. Use the UP/DOWN keys to adjust the minute setting in 10 minute increments. Press PROGRAM to accept the value.

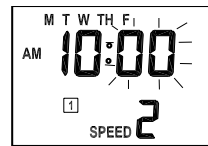

Fig. 23

4. Finally, the blower speed will be flashing. Use the UP/DOWN keys to adjust the blower speed setting from 0 to 3. Zero indicates that the blower is turned off, a setting of 1 is low, 2 is medium, and 3 represents a blower speed of high. Press PROGRAM to accept the blower speed setting. This completes the first program for weekdays.

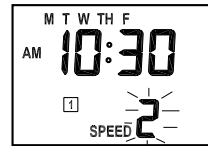

Fig. 24

5. The display will advance to the second program for weekdays with the hour position flashing. Follow steps 2 to 4 to set the second program. After setting each program, the display will advance to the next program number. After going through all four weekday programs, the unit will advance through each of the four weekend programs. The adjustment procedure (steps 2 to 4) is the same for each program.

### NOTES:

- For fast advance of the values, press and hold the UP/DOWN keys for 2 seconds. The values for program time or blower speed will advance quickly.
- To exit programming mode and return to normal operating mode, either wait 15 seconds without any key presses or press DISPLAY to immediately return to normal operating mode.
- **Once entered, the programs are active and stored in the unit's memory. You can unplug and move the air purifier and still retain the programs.**



## Programming

---

### Reviewing Programs

You may want to review the programs to confirm that the settings are still acceptable. The following steps show you how to review the programs.

#### *To review programs:*

1. With the air purifier On, press and hold the PROGRAM key. After 2 seconds, the display will advance through the 4 programs for weekdays and then the 4 programs for the weekend. You must hold the PROGRAM key as the display reviews the programs.
2. After viewing all programs, the display will return to normal operating mode and you can release the key.

#### **NOTE:**

- If you review a program that you want to change, simply release the PROGRAM key. The display will stop on that program and allow you to make changes. Refer to User Programming (pg. 16) for more details on how to change the values.

### Locking/Unlocking the Keypad

Once you enter the desired programs, you may want to lock the keypad to prevent accidental changing of the programs. When the keypad is locked, all keys will be disabled. If you press a key, "Lock" will be displayed on the screen for 1-2 seconds.

When the keypad is locked, the remote may still be used to adjust the speed or turn off the air purifier.

#### *To Lock or Unlock the Keypad:*

1. To lock the keypad, press and hold the UP/DOWN keys simultaneously for 2-3 seconds. The display will read "Lock" for 1-2 seconds.
2. To unlock the key pad, press and hold the UP/DOWN keys simultaneously for 2-3 seconds. The keypad will be functional.



**Fig. 25**

## Resetting the Air Purifier

In the unusual situation that the unit or the display is exhibiting erratic behavior, you may want to reset the air purifier. Since you will lose all of your programmed settings when the unit is reset, you should consult the Troubleshooting section (pg. 23) of the manual to resolve the problem before using the Reset Feature. When the unit is reset, the clock, day of the week, and programs will default to their factory settings and the unit will turn off. **The only information that will be saved is the pre-filter and filter counter values.** If you still have problems after resetting the air purifier, please contact Hunter for additional assistance (refer to Technical Assistance pg. 23).

### *To Reset the Air Purifier:*

1. Using a small pin or paperclip, hold down the RESET key for 2 seconds or until the display goes blank.
2. Follow the directions in the Programming section of the manual (pg. 14) to update the day, time, and programs of the unit.



## Air Purifier Maintenance

---

### Cleaning Your Air Purifier

Proper maintenance of your Hunter Air Purifier will help ensure years of trouble free service.

*Follow these steps to properly maintain your air purifier:*

1. Approximately every 90 days, the outside of the unit should be cleaned with a soft, damp cloth.
2. If needed, the front grill can be removed from the unit and cleaned with soapy water. Simply remove the pre-filter before exposing the grill to water.
3. Follow the instructions in Changing the Pre-Filter and Cleaning the Filter (pgs. 20 and 21) to determine when and how to replace the filters.

#### NOTES:

- The air purifier must be unplugged during the cleaning process.
- Be sure the unit is completely dry before plugging in and using.
- Never immerse unit in water.

### Changing the Pre-Filter

When the Pre-Filter Counter exceeds 1400 hours (refer to Filter Run-time Counters for additional information pg. 13), the display will automatically switch to the Pre-Filter Display and the Pre-Filter indicator will flash as a reminder that you should replace the pre-filter. To maintain proper odor-removing capability and overall filtration performance, the pre-filter should be changed every 1400 hours (approximately 3 months of use). If necessary, the pre-filter can be changed more often. Proper maintenance of the pre-filter will help extend the life of the cleanable filter. Refer to Obtaining Replacement Filters (pg. 22) if you need help finding replacement filters.

*To change the pre-filter and reset the pre-filter counter:*

1. First, turn off and unplug the air purifier.
2. Next, remove the front grill. Place your fingers under the handle of the front grill and pull towards you and up.
3. The pre-filter is attached to the inside of the grill with hook tape. Pull gently on the pre-filter to removed it.
4. If needed, use a soft damp cloth to wipe off the grill.
5. Install the new pre-filter by placing it in the grill and pressing gently on the pre-filter so that it adheres to the hook tape. You may notice a few black particles coming off the pre-filter. Those particles are part of the odor-removing activated carbon and will be collected on the filter during regular use.

## Air Purifier Maintenance



6. Install the grill back onto the unit. First, line up the tabs on the bottom of the grill with the openings on the purifier base and then push the top of the grill forward until it is closed.
7. Plug in the air purifier. **NOTE:** This unit will not operate unless the grill is in the correct position. The display will read “door” if the grill is not attached properly.
8. Finally, reset the pre-filter counter by pressing the DISPLAY key until the pre-filter counter is displayed. Then, hold the FILTER RESET key for 2 seconds. The pre-filter counter will return to zero and resume normal operation.



Fig. 26

### Cleaning the Filter

The PermaLife™ Filtration System uses a cleanable filter that never has to be changed, only cleaned. When the filter exceeds 2800 hours (approximately 4 to 6 months of use), the Filter Run-Time Counter will display 0% life remaining and the Filter indicator will flash (refer to Filter Run-Time Counter for additional information, pg. 13). This is a reminder that you should check the filter and clean if necessary. The proper time to clean the filter depends on usage and the environment. Use the following list to help determine if the filter should be cleaned:

- Compare the color of the filter to the color coded chart on the inside of the housing. If the filter color matches the darkest color on the chart, you should clean the filter.
- If you notice a decrease in air output or an increase in noise at any time during normal operation, the filter may be clogged. Clean the filter to return to normal operation.

#### *To clean the filter and reset the filter run-time counter:*

1. First, turn off and unplug the air purifier.
2. Next, remove the front grill. Place your fingers in the recesses on either side of the top of the grill and pull firmly.
3. Gently pull on the filter to remove it from the unit. While removing the filter, note the directional arrows printed on the top of the filter. The filter will be reinstalled with the same orientation. Refer to Fig. 27.
4. The label on the top side of the filter points to the side that should be cleaned. Refer to Fig. 27. With a vacuum cleaner and upholstery brush attachment, clean the filter until all particles are removed. Do not use water or liquids to clean.
5. Install the filter with arrows pointing towards the unit. Refer to Fig. 27. Press the filter firmly into the air purifier. To avoid damaging the filter media, you should press on the frame of the filter only.

*Continued*



A

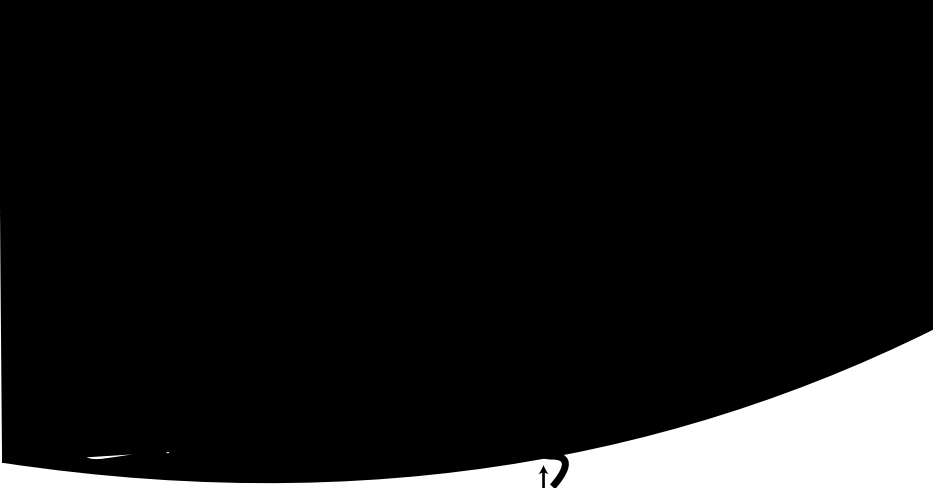

Fig. 27



# Troubleshooting



<b>Problem</b>	<b>Solutions</b>
1. No Display	<ul style="list-style-type: none"><li>• Confirm that the unit is plugged in.</li><li>• Check the installation of the front grill.</li><li>• Reset the air purifier. (See Resetting the Air Purifier on pg. 19.)</li></ul>
2. Display reads “door.”	<ul style="list-style-type: none"><li>• The front grill is not attached properly. Remove grill from unit and re-attach. (See Initial Operation on pg. 6.)</li></ul>
3. Program number is flashing.	<ul style="list-style-type: none"><li>• Unit is in temporary program override mode. Refer to Override of Auto Mode on pg. 12.</li></ul>
4. Programs are not running.	<ul style="list-style-type: none"><li>• Confirm that the unit is in Auto Mode. The Auto indicator should be lit and a program number should be illuminated. (See Auto Mode on pg. 10.)</li><li>• Review program settings to confirm program set points. (See Reviewing Programs on pg. 18 for additional information.)</li></ul>
5. Time is not correct	<ul style="list-style-type: none"><li>• Check that the proper display is chosen. (See Display Modes on pg. 9).</li><li>• Set the time. (See Setting the Day/Time on pg. 14.)</li></ul>
6. Keypad does not work or display reads “Lock.”	<ul style="list-style-type: none"><li>• Key pad has been locked to prevent accidental changes to the programs. (See Keypad Lock on pg. 18 to unlock the key pad.)</li></ul>
7. Erratic Display or Operation.	<ul style="list-style-type: none"><li>• Reset the air purifier. (See Resetting the Air Purifier on pg. 19.)</li></ul>
8. Filter and/or Pre-filter Indicator is Flashing.	<ul style="list-style-type: none"><li>• The Filter and/or Pre-Filter Counters have reached the estimated usage times. Check and replace or clean filters if needed. (Refer to Filter and Pre-Filter Counters on pg. 13.)</li></ul>
9. Unit has reduced air flow or increased noise.	<ul style="list-style-type: none"><li>• The filter is clogged and should be changed. (Refer to Cleaning the Filter on pg. 21.)</li></ul>
10. Remote is not working properly.	<ul style="list-style-type: none"><li>• Be sure that the remote is facing the air purifier when pressing the key.</li><li>• Check the batteries. (Refer to Remote Operation on page 8.)</li></ul>

## Technical Support

If you have any additional questions or problems with your Hunter air purifier, please call 1-888-830-1326 from 8:00 am to 5:00 pm Central Time or contact us over the Internet at [www.hunterfan.com](http://www.hunterfan.com).



## Warranty

---

### Hunter Fan Company PermaLife™ Air Purifier **5 YEAR LIMITED WARRANTY**

The Hunter Fan Company makes the following limited warranty to the original residential user or consumer purchaser of the PermaLife™ Air Purifier:

If any part of your PermaLife™ Air Purifier motor or control panel fails during the first five (5) years from the date of installation due to a defect in material or workmanship, we will provide a replacement Air Purifier free of charge. Installation is deemed to occur at the date of purchase.

If the Air Purifier cord or front grill fails any time within one (1) year after installation due to a defect in material or workmanship, we will replace or, at our option, repair the unit free of charge at our nearest service center or at our Service Department in Memphis, Tennessee. You will be responsible for all parts and labor costs after this one-year period.

USE OF A NON-HUNTER FILTER WILL INVALIDATE THIS WARRANTY. IF THE ORIGINAL RESIDENTIAL USER OR CONSUMER PURCHASER CEASES TO OWN THE AIR PURIFIER, THIS WARRANTY AND ANY IMPLIED WARRANTY WHICH THEN REMAINS IN EFFECT, INCLUDING BUT NOT LIMITED TO ANY IMPLIED WARRANTY OF MERCHANTABILITY OR FITNESS FOR A PARTICULAR PURPOSE, ARE VOIDED.

NO WARRANTY, EXPRESSED OR IMPLIED, INCLUDING ANY WARRANTY OF MERCHANTABILITY OR FITNESS FOR A PARTICULAR PURPOSE, IS MADE IN RESPECT TO THE FILTER MATERIAL OR CARBON FILTER.

THIS WARRANTY IS IN LIEU OF ALL OTHER EXPRESS WARRANTIES. THE DURATION OF ANY IMPLIED WARRANTY INCLUDING BUT NOT LIMITED TO ANY IMPLIED WARRANTY OF MERCHANTABILITY OR FITNESS FOR A PARTICULAR PURPOSE, IN RESPECT TO THE MOTOR IS EXPRESSLY LIMITED TO THE PERIOD OF THE EXPRESS WARRANTY SET FORTH ABOVE.

This warranty is voided if the air purifier is not purchased and used in the USA or Canada.

This warranty excludes and does not cover defects, malfunctions or failures of the Air Purifier which were caused by repairs by persons not authorized by us, use of parts or accessories not authorized by us, mishandling, modifications, or damage to the Air Purifier while in your possession, or unreasonable use, including failure to provide reasonable and necessary maintenance. This warranty does not cover Air Purifiers used in commercial applications. There are no express or implied warranties as to commercial purchasers or users.

To obtain service, contact the nearest Hunter authorized service center or the Hunter Fan Company Service Department, 2500 Frisco Avenue, Memphis, Tennessee 38114, 1-888-830-1326. For the name of our nearest authorized Hunter Fan Company Service Center, write to the Hunter Fan Company at the preceding address. You will be responsible for



## Warranty



insurance and freight or other transportation to our factory service center. We will return the Air Purifier freight prepaid. The Air Purifier should be properly packaged to avoid damage in transit since we will not be responsible for any such damage. Proof of purchase is required when requesting warranty service. The purchaser must present sales receipt or other document that establishes proof of purchase.

IN NO EVENT SHALL HUNTER FAN COMPANY BE LIABLE FOR DIRECT, INDIRECT, SPECIAL CONSEQUENTIAL OR INCIDENTAL DAMAGES IN EXCESS OF THE PURCHASE PRICE OF THE AIR PURIFIER. YOUR SOLE REMEDY WILL BE REPAIR OR REPLACEMENT AS PROVIDED ABOVE.

SOME AMERICAN STATES AND CANADIAN PROVINCES DO NOT ALLOW:

- LIMITATIONS ON HOW LONG AN IMPLIED WARRANTY LASTS;
- THE EXCLUSION OR LIMITATION OF DIRECT, INDIRECT SPECIAL, INCIDENTAL OR CONSEQUENTIAL DAMAGES;

SO THE ABOVE LIMITATIONS MAY NOT APPLY TO YOU.

THIS WARRANTY GIVES YOU SPECIFIC LEGAL RIGHTS AND YOU MAY ALSO HAVE OTHER RIGHTS WHICH VARY FROM STATE TO STATE OR PROVINCE TO PROVINCE.



The energy efficiency of this ENERGY STAR qualified model is measured based on a ratio between the model's CADR for Dust and the electrical energy it consumes, or CADR/Watt.

## Other Home Comfort Products from Hunter

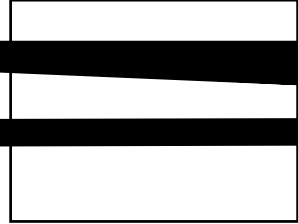
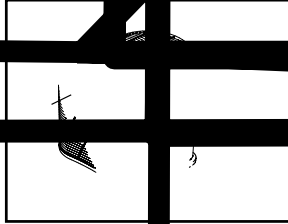
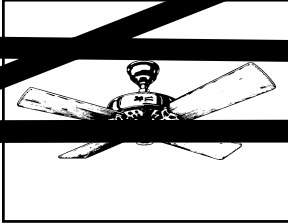

The Case-Free  
Humidifier™

Programmable  
Thermostat

To learn more about Hunter Fan Company products, please see our Web page at:

[www.hunterfan.com](http://www.hunterfan.com)